

BA488CF-F
FOUNDATION™ fieldbus
Intrinsically safe
Panel mounting display

issue 12

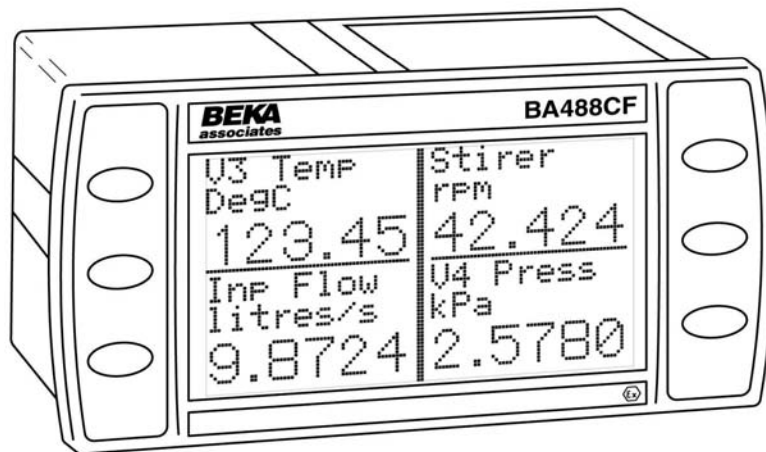

CONTENTS

1. Description

- 1.1 Documentation
- 1.2 Version 2.3 firmware

2. Operation

- 2.1 Controls

3. Intrinsic Safety Certification

- 3.1 ATEX certificate
- 3.2 Zones, gas groups and T rating
- 3.3 Fieldbus connection
- 3.4 External switches
- 3.5 Alarm outputs
- 3.6 Certification label information

4. System Design for Hazardous Area

- 4.1 FISCO Systems
- 4.2 Non FISCO Systems
- 4.3 External switches
- 4.4 Alarm outputs

5. Installation

- 5.1 Location
- 5.2 Installation procedure
- 5.3 EMC

6. Display & Alarm Configuration

- 6.1 Default configuration
- 6.2 Accessing the display configuration menus
- 6.3 Configurable functions
 - 6.3.1 Screens (Display format)
 - 6.3.2 Input settings
 - 6.3.3 Tags
 - 6.3.4 Units
 - 6.3.5 Alarms
 - 6.3.5.1 Alarm Summary
 - 6.3.5.2 Alarm Activation
 - 6.3.5.3 Alarm Output
 - 6.3.6 Display
 - 6.3.6.1 Settings
 - 6.3.6.2 Quick Access
 - 6.3.6.3 Access Code
 - 6.3.6.4 Status Text
 - 6.3.6.5 Last Input
 - 6.3.7 Keys
 - 6.3.8 Code
 - 6.3.9 Unit Info
 - 6.3.10 Defaults
 - 6.3.10.1 Display Defaults
 - 6.3.10.2 Interface Board Defaults.
 - 6.3.10.3 Revisions 1 & 2
- 6.4 Quick Access Menu

7. Programming

8. Maintenance

- 8.1 Fault finding during commissioning
- 8.2 Fault finding after commissioning
- 8.3 Servicing
- 8.4 Routine maintenance
- 8.5 Guarantee
- 8.6 Customer comments

9. Accessories

- 9.1 Tag number
- 9.1 FOUNDATION™ fieldbus Interface Guide.

10. Index

Appendix 1

FM Approval for use in the USA

Appendix 2

IECEx certification

**The BA488CF-F is CE marked to show compliance with the
European Explosive Atmospheres Directive 94/9/EC
and the European EMC Directive 2004/108/EC**

1. DESCRIPTION

The BA488CF-F FOUNDATION™ fieldbus display is an intrinsically safe instrument that can display up to eight FOUNDATION™ fieldbus process variables, together with their units of measurement and tag information. The instrument is bus powered so no additional power supply is required.

The instrument's communications protocol is shown on the rear panel. The '-F' order code suffix also indicates the protocol but is not shown on the instrument certification label. There is an alternative version of the fieldbus display, order code BA488CF-P for use on Profibus PA networks.

The BA488CF-F FOUNDATION™ fieldbus display may be ordered, or configured on-site, with alternative function blocks allowing use with most FOUNDATION™ fieldbus hosts.

Revision 1

One Multiple Analogue Output
(1 x MAO)

Revision 2

Two Input Selectors
(2 x IS)

The required Device Description files, which may be downloaded from either the Fieldbus Foundation or the BEKA websites, depend upon which BA488CF-F FOUNDATION™ fieldbus display revision is selected.

Eleven selectable standard display formats enable one, two, three, four or eight process variables, some with bargraphs to be displayed on one screen.

The BA488CF-F FOUNDATION™ fieldbus display can be supplied with six optional alarm outputs that may be linked to any of the displayed fieldbus variables. These alarm outputs are locally activated from the fieldbus variables and are configured via the instrument menu and push buttons. They can not be controlled via the fieldbus.

The instrument has been certified intrinsically safe by European Notified Body Intertek Testing Services (ITS) to the ATEX Directive 94/9/EC for use in potentially explosive gas atmospheres.

For use in the USA the instrument has intrinsic safety and nonincendive FM Approval – see Appendix 1, plus IECEx intrinsic safety approval for international applications – see Appendix 2.

Housed in a robust 72 x 144 panel mounting DIN enclosure, the BA488CF-F FOUNDATION™ fieldbus display has an IP66 front panel and is supplied with a gasket to seal the joint between the instrument and the panel.

1.1 Documentation

This instruction manual describes system design, conditioning and installation of the BA488CF-F FOUNDATION™ fieldbus display. For detailed commissioning information please refer to the FOUNDATION™ fieldbus Interface Guide that can be downloaded from the BEKA website www.beka.co.uk

1.2 Version 2.3 Firmware

This manual describes the enhanced features of BA488CF-F FOUNDATION™ fieldbus displays employing version 2.3 firmware that was released in April 2011 following an interim update to version 2.0 in December 2005.

The new features include:

Standard screens increased to 11

Multiple bargraph limits added

Input scaling added

Selectable function blocks added:

Revision 1

1 x MAO (multiple analogue output)

or Revision 2

2 x IS (Input selector)

Option added to remove status text from single variable screens.

Last variable parameter added to prevent the display of unused inputs.

The instrument's firmware version can be established using the 'Unit Info' function in the main configuration menu – see section 6.3.9 of this manual.

BA488CF-F FOUNDATION™ fieldbus displays employing version 2.3 firmware are backwards compatible with all earlier versions of the instrument.

2. OPERATION

Fig 1 shows a simplified block diagram of the BA488CF-F FOUNDATION™ fieldbus display. When the optional alarms are not fitted, the instrument only requires a two-wire connection to the fieldbus.

How much of the BA488CF-F FOUNDATION™ fieldbus display configuration can be performed via the fieldbus depends upon the instrument version and the system host. Parameters that can not be configured via the fieldbus can be set via the four front panel push buttons. Menus enable the required standard display format to be selected and the units of measurement, plus tag information for each displayed fieldbus variable to be entered. Each fieldbus variable may be individually offset and scaled, and when a standard screen including a bargraph is selected, the limits of each bargraph can be set.

The optional alarms are locally activated from the fieldbus variables and can only be configured and the setpoints adjusted using the BA488CF-F push buttons. The alarms can not be configured or controlled via the fieldbus.

Description Files for the BA488CF-F FOUNDATION™ fieldbus display may be downloaded from either the Fieldbus Foundation or from the BEKA associates websites.

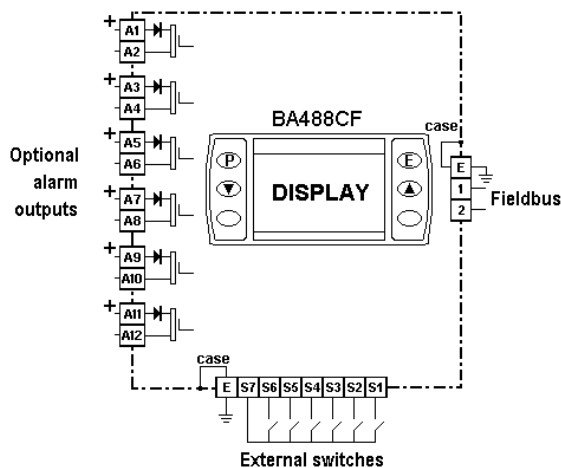

Fig 1 Simplified block diagram of BA488CF-F

2.1 Controls

The user can scroll through the display screens by operating the ▼ or ▲ push buttons. The number of screens available depends upon how the BA488CF-F display has been configured. If one fieldbus variable per screen has been configured, eight screens will be present; if four fieldbus variables per screen have been configured, only two screens will be available.

Irrespective of the number of fieldbus variables assigned to the BA488CF-F, the instrument always has provision for displaying eight variables. Unassigned inputs are displayed as zero with a bad data warning i.e. light digits on a dark background. The Last Input parameter allows unused inputs to be skipped when scrolling through the instrument display screens, see section 6.3.6.5.

If enabled, operating the **P** and **▲** push buttons simultaneously activates the Quick Access Menu, allowing the user to adjust the display contrast without providing access to any of the other configuration parameters. Additional security may be provided by an optional access code.

3. INTRINSIC SAFETY CERTIFICATION

3.1 ATEX certificate

The BA488CF-F has been issued with EC-Type Examination Certificate by Notified Body Intertek Testing Services (ITS) confirming compliance with the European ATEX Directive 94/9/EC for Group II, Category 1, gas atmospheres, EEx ia IIC T4. The instrument bears the Community Mark and, subject to local codes of practice, may be installed in any of the European Economic Area (EEA) member countries. ATEX certificates are also acceptable for installations in Switzerland.

Some of the standards specified may have subsequently been deharmonised, see BEKA Declaration of Conformity for current conformity

This manual describes installations which conform with EN 60079:Part14 Electrical Installation in Hazardous Areas. When designing systems for installation outside the UK, the local Code of Practice should be consulted.

3.2 Zones, gas groups and T rating

The BA488CF-F has been issued with EC Type Examination certificate ITS04ATEX22779 confirming that it complies with the requirements for Group II Category 1 G EEx ia IIC T4 (Tamb –40 to 60°C) specified in the ATEX Directive. When connected to a suitable system the BA488CF-F may be installed in:

Zone 0	explosive gas air mixture continuously present.
Zone 1	explosive gas air mixture likely to occur in normal operation.
Zone 2	explosive gas air mixture not likely to occur, and if it does will only exist for a short time.

Be used with gases in groups:

Group A	propane
Group B	ethylene
Group C	hydrogen

Having a temperature classification of:

T1	450°C
T2	300°C
T3	200°C
T4	135°C

At an ambient temperature between –40 and +60°C.

Note: the guaranteed operating temperature range of the Fieldbus Display is –20 to +60°C

This allows the BA488CF-F to be installed in all Zones and to be used with most common industrial gases.

WARNING installation in Zone 0

When installed in a Zone 0 potentially explosive atmosphere requiring apparatus of Category 1G, the fieldbus display shall be installed such that even in the event of rare incidents, an ignition source due to impact or friction between the aluminium enclosure at the rear of the instrument mounting panel and iron/steel is excluded.

3.3 Fieldbus connection

The BA488CF-F FOUNDATION™ fieldbus display is powered and communicates via the fieldbus, which is connected to terminals 1 and 2. These terminals comply with the Fieldbus Intrinsically Safe Concept (FISCO) defined in EN 60079 Part 27 which simplifies intrinsic safety system design.

The BA488CF-F may also be connected to non FISCO compliant fieldbus segments by using the entity concept to assess safety.

Terminals 1 and 2 of the BA488CF-F FOUNDATION™ fieldbus FOUNDATION™ fieldbus display are not polarised and have the following safety parameters:

U _i	=	17.5V dc
I _i	=	380mA dc
P _i	=	5.32W

For non FISCO compliant segments, the safety parameters of the power supply or isolator powering the fieldbus segment must be equal to or less than these figures.

The maximum equivalent capacitance and inductance at terminals 1 & 2 of the BA488CF-F Fieldbus Display are:

C _i	=	1nF
L _i	=	8µH

To determine cable parameters for non FISCO compliant segments, the sum of C_i and L_i of all the field devices should be subtracted from the maximum cable parameters permitted by the device powering the fieldbus segment.

3.4 External switches

For applications requiring operator inputs to be made by large industrial push buttons, terminals S1 to S7 facilitate external switches to be connected to the Fieldbus Display. When external switches are connected, the BA488CF-F may be configured so that the front panel push buttons continue to function or are disabled.

Terminals S1 to S7 have the following combined output safety parameters:

$$\begin{aligned} U_o &= 14.7V \text{ dc} \\ I_o &= 146.7mA \text{ dc} \\ P_o &= 0.58W \end{aligned}$$

The switches and associated wiring connected to the terminals must comply with the requirements for *simple apparatus*. i.e. the switch must be mechanically activated and have IP20 protection, and both the switch and the wiring must be capable of withstanding a 500V rms insulation test to earth for one minute. Most industrial push buttons and wiring satisfy these requirements.

The input safety parameters of terminals S1 to S7 are zero, therefore only switches or intrinsically safe relays may be connected.

The total maximum permitted cable parameters for all the cables connected to terminals S1 to S7 in a IIC hydrogen gas must be less than:

$$\begin{aligned} C_o &= 0.22\mu F \\ L_o &= 0.26mH \end{aligned}$$

Although these parameters are not restrictive, for reliable operation it is recommended that the cables between the fieldbus display and the external push buttons are less than 5m long.

3.5 Alarm outputs

Each of the six optional alarm outputs is a separate galvanically isolated solid state switch. The EC-Type Examination Certificate specifies that under fault conditions the voltage, current and power at each switch output will not exceed those specified for *simple apparatus* in section 5.7 of EN 60079-11. This allows each of the BA488CF-F alarm outputs to be connected to any intrinsically safe circuit protected by a certified Zener barrier or galvanic isolator providing that the output parameters of each circuit are less than:

$$\begin{aligned} U_o &= 28V \text{ dc} \\ I_o &= 200mA \\ P_o &= 0.84W \end{aligned}$$

The maximum equivalent capacitance and inductance of each BA488CF-F alarm output is:

$$\begin{aligned} C_i &= 40nF \\ L_i &= 20\mu H \end{aligned}$$

To determine the maximum permissible cable parameters, C_i and L_i must be subtracted from the maximum cable capacitance and inductance specified by the system certificate of the circuit connected to the switch.

3.6 Certification Label Information

The certification label is fitted in a recess on the top outer surface of the enclosure. It shows the ATEX certification information, a statement that the instrument is a FISCO Field Device, plus BEKA associates name and location. Non European certification information may also be included.



4. SYSTEM DESIGN FOR HAZARDOUS AREAS

4.1 FISCO Systems

The BA488CF-F FOUNDATION™ fieldbus display may be connected to any FISCO compliant fieldbus segment providing that the power supply or isolator powering the segment can provide 25mA required by the BA488CF-F Display.

Fig 2 shows a typical fieldbus segment. To comply with FISCO requirements, the power supply, terminators, field devices and the interconnecting cables must conform with IEC60079 part 27.

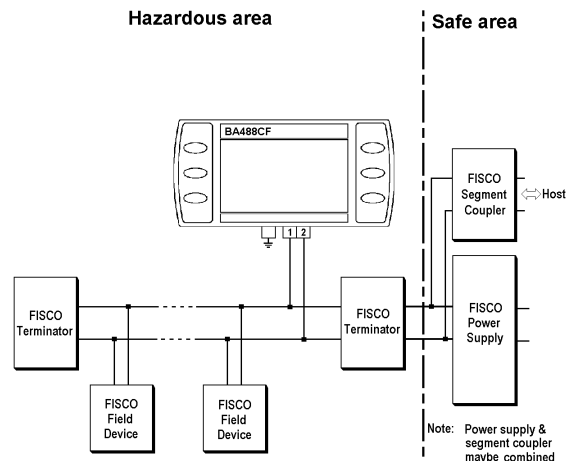

Fig 2 FISCO fieldbus system

4.2 Non FISCO Systems

If the BA488CF-F FOUNDATION™ fieldbus display is to be connected to a fieldbus segment that does not comply with FISCO requirements, the safety parameters of the power supply and the BA488CF-F must be compared using the entity concept.

The maximum output safety parameters of the device powering the fieldbus segment must be equal to, or less than, the input safety parameters of terminals 1 & 2 of the BA488CF-F FOUNDATION™ fieldbus display, namely:

$$\begin{aligned} U_i &= 17.5V \text{ dc} \\ I_i &= 380mA \text{ dc} \\ P_i &= 5.32W \end{aligned}$$

The maximum permitted cable parameters for the fieldbus segment must be reduced by the equivalent internal capacitance C_i and inductance L_i of the BA488CF-F. The BA488CF-F equivalent capacitance and inductance are very small and make little practical difference.

$$\begin{aligned} C_i &= 1nF \\ L_i &= 8\mu H \end{aligned}$$

4.3 External switches

For applications requiring operator inputs to be made by large industrial push buttons, terminals S1 to S7 allow up to six external switches to be connected to the Fieldbus Display. When external switches are connected the front panel push buttons may be operated in parallel or disabled – see section 6.3.7

For installation in a hazardous area the switches and associated wiring must comply with the requirements for *simple apparatus*. i.e. the switch must be mechanically activated and have IP20 protection, and both the switch and the wiring must be capable of withstanding a 500V rms insulation test to earth for one minute. Most industrial push buttons and wiring satisfy these requirements.

Although the allowable cable parameters are large, it is recommended that the cables are less than 5m long.

If a safe area switch is to be connected to a Fieldbus Display located in a hazardous area, the switch contact must be transferred via a certified intrinsically safe relay or a galvanic isolator having zero output safety parameters as shown in Fig 3.

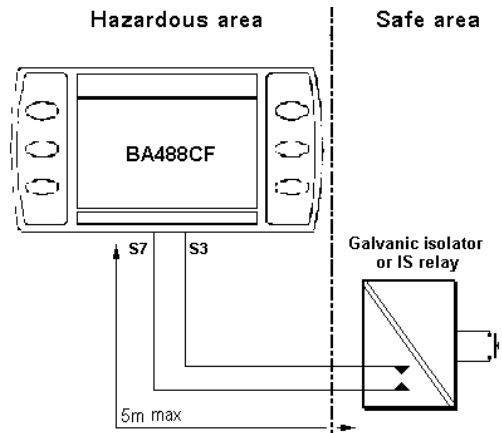

Fig 3 External push button switch in safe area

4.4 Alarm outputs

Each alarm output is a galvanically isolated single pole solid state switch output as shown in Fig 4.

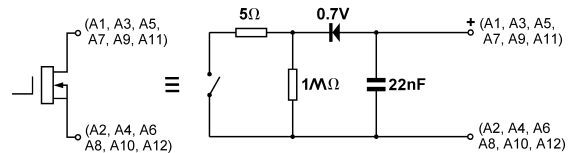

Fig 4 Equivalent circuit of each switch output

The outputs are polarised and current will only flow in one direction. Odd numbered terminals should be connected to the positive side of the supply.

$$\begin{aligned} R_{on} &= 5\Omega + 0.7V \\ R_{off} &= \text{greater than } 1M\Omega \end{aligned}$$

Note: Because of the series protection diode, some test meters may not detect a closed alarm output

WARNING

These Alarm Outputs should not be used for critical safety applications such as an emergency shut down system.

When the BA488CF-F FOUNDATION™ fieldbus display is disconnected from the fieldbus, or the fieldbus is de-energised all the alarm outputs will open irrespective of how they have been configured.

5. INSTALLATION

5.1 Location

The BA488CF-F FOUNDATION™ fieldbus display is housed in a robust aluminium enclosure with a toughened glass window mounted in a Noryl bezel. The front of the instrument provides IP66 protection and a gasket seals the joint between the instrument enclosure and the panel. The instrument may be installed in any panel providing the environmental limits shown in the specification are not exceeded.

CAUTION

Special conditions apply for installation in Zone 0, see section 3.2

Fig 5 shows the overall dimensions of the BA488CF-F and the panel cut-out. To achieve an IP66 seal between the instrument enclosure and the panel, the smaller cut-out must be used and the instrument secured with four panel mounting clips.

The BA488CF-F liquid crystal display has maximum contrast when viewed from directly ahead and slightly below the centre line of the instrument.

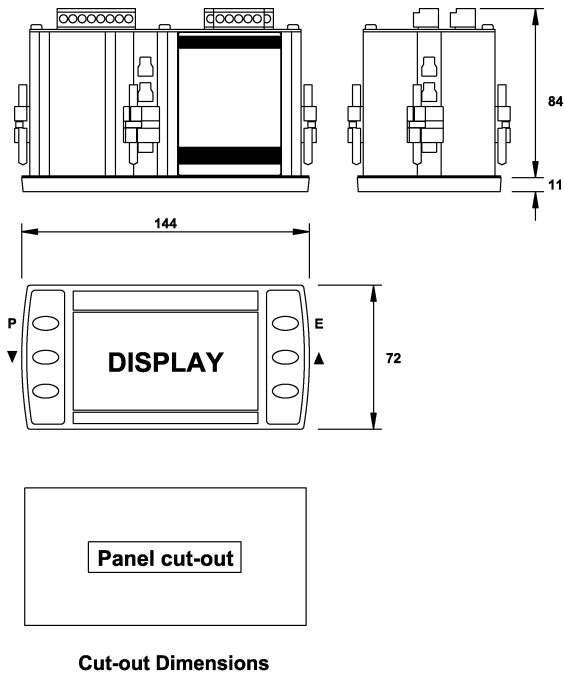

DIN 43 700
138.0 +1.0/-0.0 x 68.0 +0.7/-0.0

To achieve an IP65 seal between instrument enclosure and panel
136.0 +0.5/-0.0 x 66.2 +0.5/0.0

Fig 5 BA488CF-F dimensions

5.2 Installation Procedure

- a. Insert the BA488CF-F into the instrument panel cut-out from the front of the panel.
- b. Fix panel mounting clips to opposite sides of the instrument and tighten until the instrument is secure. Four clips are required to achieve an IP66 seal between the instrument enclosure and the panel.
- c. Connect the panel wiring to the rear terminal block(s) as shown in Fig 6. To simplify installation, the terminals are removable so that panel wiring can be completed before the instrument is installed.

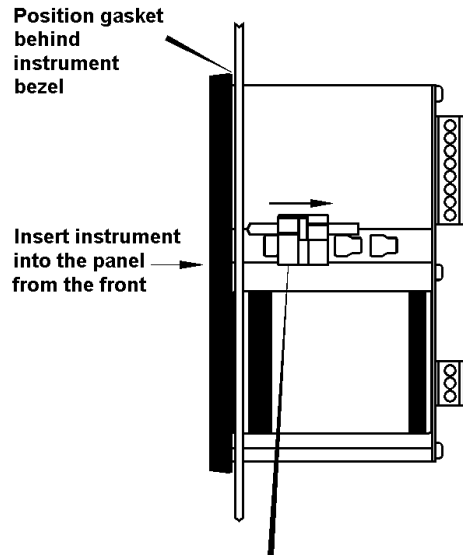

Slide panel mounting clip into the slotted rail on the side of the enclosure. Four clips are required to achieve an IP66 seal between instrument and panel.

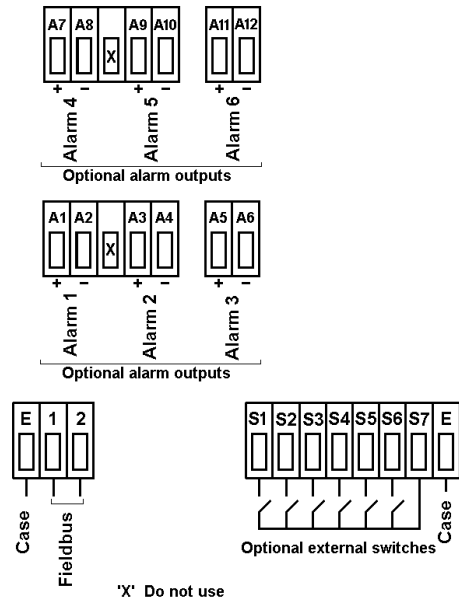

Fig 6 Installation and terminal connections

5.3 EMC

The BA488CF-F complies with the requirements of the European EMC Directive 2004/108/EC. For specified immunity all wiring should be in screened twisted pairs with the screens connected to the potential equalising network as recommended in EN 60079-14.

6. DISPLAY & ALARM CONFIGURATION

In addition to loading the BA488CF-F FOUNDATION™ fieldbus display Device Description files onto the system host and defining up to eight fieldbus variables that are to be displayed, the instrument display and alarms, if fitted, have to be configured. How much of this configuration can be done via the fieldbus depends upon the instrument version and the system host. Parameters that can not be configured via the fieldbus, may be set via the four front panel push buttons

All the display and alarm configuration functions are contained in an easy to use menu that is shown in Fig 7. Where necessary the sub-menus contain on-screen prompts to guide the user through each adjustment.

When navigating through the configuration menu, the push button(s) should be held until the required screen is displayed.

6.1 Default configuration

Unless otherwise requested at the time of ordering, BA488CF-F FOUNDATION™ fieldbus displays will be supplied configured as follows:

Keys	Both
Display brightness	100%
Display contrast	50%
Quick access menu	On
Quick access menu code	0000
Configuration menu access code.	0000
Screen	Single variable
Number Format	Auto
All alarms	Disabled
Alarm activation	Good data only
Alarm outputs	N/C
Bargraph	
Low	0
High	100
Input scaling	
Zero offset	0
Gain factor	1
Status text	On
Last input	8
Revision	Revision 2 (2 x IS function blocks)

6.2 Accessing the display configuration menu

Throughout this manual push buttons are shown in italics e.g. *P E ▼ ▲* and legends displayed by the instrument are shown within inverted commas e.g. 'Enter Access Code'.

Operating the *P* and *E* push buttons simultaneously accesses the display configuration menu. If the BA488CF-F is not protected by an access code the main menu will be displayed. If an access code other than the default code 0000 has already been entered, the BA488CF-F will request that the access code be entered.

Using the ▼ or ▲ button set the first digit of the code which will be flashing. Pressing *P* will transfer control to the next digit, which should be adjusted in the same way. When all four digits have been set, pressing the *E* button will enter the access code. If the code is correct the main menu will be displayed, if the code is incorrect 'Invalid Code' will be displayed.

When entering an access code, timeout will occur and the instrument will automatically return to the operating mode ten seconds after a push button was last operated. In all other menus, timeout occurs after sixty seconds.

The structure of the display configuration menu is shown in Fig 7. Navigation is achieved by highlighting the required function using the ▼ and ▲ buttons and then operating the *P* button to display the selected function sub-menu, from which a further selection or adjustment may be made. Operating the *E* button moves the display back up one level.

A flashing highlight indicates that an option or alphanumeric character may be selected using the ▼ and ▲ buttons and entered using the *E* button. If only one entry or adjustment can be made in a sub-menu, the display will automatically move up one menu level when the adjustment is entered. If more than one adjustment can be made in a sub-menu, the highlight may be moved to the second variable using the ▼ or ▲ button after the first setting has been entered. Operating the *P* button allows the second variable to be adjusted.

When multiple numeric or alpha characters are adjusted e.g. an alarm setpoint or a tag legend, the adjustment is made one digit at a time using the ▼ and ▲ buttons. After the first flashing digit has been set as required, the flashing highlight can be moved to the next digit by operating the *P* button. When all digits have been set, operating the *E* button will enter the setting.

Following completion of the instrument configuration, the *E* button should be operated to step the display back to the main menu. One more operation of the *E* button will then return the BA488CF-F to the operating mode.

6.3 Configurable functions

This section provides an explanation of each configurable function and should be read in conjunction with Fig 7.

6.3.1 Screens (Display format)

The BA488CF-F can display up to eight fieldbus variables. These are identified as IN_1 to IN_8. The fieldbus variable that each one represents is determined by the BA488CF-F configuration at the fieldbus system host – see the *FOUNDATION™ fieldbus Interface Guide*.

This sub-menu allows one of eleven standard display formats to be selected. The standard formats contain one, two, three, four or eight fieldbus variables some with bargraphs as shown below.

The ‘Text Display’ option which enabled custom formats to be created is deprecated i.e. still available but no longer actively supported.

One variable + horizontal bargraph

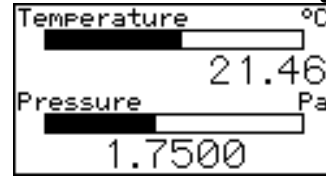

Two variables + horizontal bargraphs

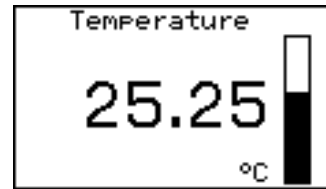

One variable + vertical bargraph

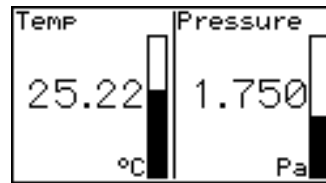

Two variables + vertical bargraphs

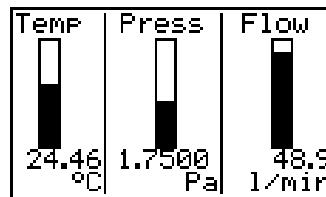

Three variables + vertical bargraphs

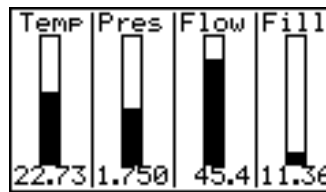

Four variables + vertical bargraphs

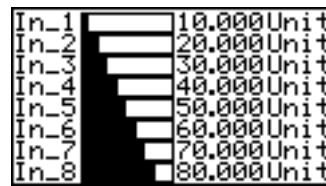

Eight variables + horizontal bargraphs



One variable

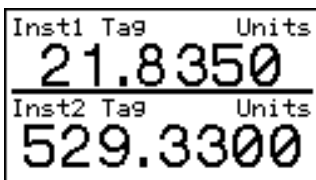

Two variables

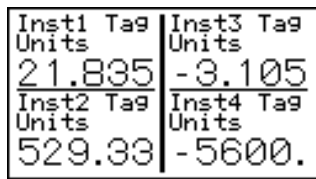

Four variables

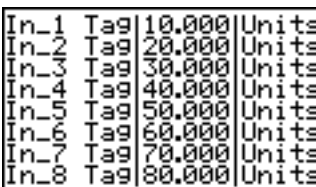

Eight variables

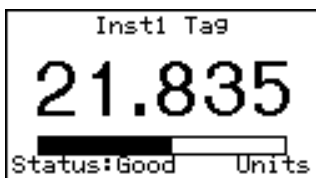

6.3.2 Input Settings

Note: Only included in Revision 1 instruments. Omitted from Revision 2 instruments because these parameter can be easily configured in the Display Transducer Block.

The Input Setting function is divided into two groups of sub-functions. The first, ‘BarLimits Src’ is included to maintain backwards compatible with earlier firmware issues in which fieldbus variables IN_7 and IN_8 were used to define all the bargraph limits. This reduced the number of fieldbus variables that could be displayed with

bargraphs from eight to six. Version 2.3 firmware includes the improved 'Per Input' option that enables the lower and upper limits of a bargraph for each of the eight fieldbus variables to be defined via the front panel push buttons. It is recommended that 'Per Input' option be used for new installations.

In addition to defining individual limits for up to eight bargraphs, the second group of sub-functions enables the decimal point position for each display to be defined. Each of the eight fieldbus inputs may also be offset and scaled before being displayed which allows variables to be displayed in alternative units of measurement.

$$\text{Display} = (\text{Gain} \times \text{Fieldbus variable}) + \text{Offset}$$

The sub-functions for each input are:

'Offset' Adds a positive or negative offset to the fieldbus variable before it is displayed.

'Gain' Multiplies the fieldbus variable by a factor before it is displayed.

'Bar Lo' Defines the bargraph lower limit

'Bar Hi' Defines the bargraph higher limit

'Format' Defines the position of the displayed decimal point.
Six options are available:

- Auto: Max resolution with selected display format.
- 4 DP 4 digits on right of decimal point
- 3 DP 3 digits on right of decimal point
- 2 DP 2 digits on right of decimal point
- 1 DP 1 digit on right of decimal point
- 0 DP No decimal point

The total number of display digits available depends upon the display screen selected – see 6.3.1

Standard Screen	Description	Digits
1	1 variable	5, 7, 11 or 17*
2	2 variables	7
3	4 variables	5
4	8 variables	5
5	1 variable + H bar	5, 7, 11 or 17*
6	2 variables + H bars	7
7	1 variable + V bar	6
8	2 variables + V bars	4
9	3 variables + V bars	6
10	4 variables + V bars	4
11	8 variables + H bars	5

* Font automatically resizes in auto mode

If a negative number is likely to be displayed, a digit must be allocated for the negative sign. If the display overranges all the digits will display '?'.
For all options leading zeros are automatically suppressed.

6.3.3 Tags

Note: Only included in Revision 1 instruments. Omitted from Revision 2 instruments because tags can be easily defined in the Display Transducer Block.

Each of the eight fieldbus variables may be displayed with an individual tag that can contain up to sixteen alphanumeric characters. This menu allows these tags to be entered. After selecting the required variable, the tag legend is entered character by character using the ▼ and ▲ push buttons. Numbers, upper & lower case letters and symbols are available.

6.3.4 Units

Note: Only included in Revision 1 instruments. Omitted from Revision 2 instruments because units of measurement can be easily defined in the Display Transducer Block.

Each of the eight fieldbus variables may be displayed with units of measurement that can contain up to eight alphanumeric characters. This menu allows these units of measurement to be entered. After selecting the required variable, the unit of measurement is entered character by character using the ▼ and ▲ push-buttons. Numbers, upper & lower case letters and symbols are available.

6.3.5 Alarms

Note: *Alarm menus are only included when the BA488CF-F is fitted with optional alarm outputs. Outputs are locally activated from the fieldbus variables and are configured via the instrument menus and push buttons. They can not be controlled via the fieldbus.*

Each of the six alarms may be linked to any one of the eight fieldbus variables displayed by the BA488CF-F. Each alarm output can be conditioned to function as a high or a low alarm, or as a combined high and low alarm. The output can be conditioned as normally open 'N/O', or normally closed 'N/C' in the non-alarm condition. Irrespective of settings alarm outputs will be open when the instrument is not powered from the fieldbus.

When an alarm is activated, the associated fieldbus variable display flashes, i.e. alternates between dark figures on a light background and light figures on a dark background.

There are eight alarm-conditioning sub-menus.

6.3.5.1 Alarm summary

Shows to which fieldbus variable each alarm is linked and how each alarm has been conditioned i.e. high, low, or combined high & low alarm with normally open or closed output. No adjustments can be made in this sub-menu.

6.3.5.2 Alarm activation

Fieldbus variables that have not been validated are displayed with dark characters on a light background, and some screen formats also contain a status indication. This sub-menu allows the alarm outputs to be conditioned so that they only operate with validated fieldbus data, or to operate irrespective of data validity.

6.3.5.3 Alarm output

There is a separate sub-menu for each of the six alarm outputs; these link the alarm to one of the displayed fieldbus variables and define the alarm function and the setpoints.

To link the alarm to a displayed variable, position the cursor over the 'IN_n' field, press **P** and using the ▼ or ▲ button select the required input source. Enter the selection by pressing the **E** button.

Each alarm output can be N/O or N/C in the non-alarm condition. To change the setting, position the highlight over the 'N/O' or 'N/C' field, press **P** and use the ▼ or ▲ button to toggle the setting. Enter the selection by pressing the **E** button.

Each alarm has three functions that can be independently enabled to condition the output as a low or high alarm, or as a combined low and high alarm, either with or without hysteresis.

The required functions can be individually enabled by positioning the highlight over the Enb/Dis (Enabled/Disabled) column, pressing **P** and toggling the function to the required state, then entering the selection by pressing the **E** button.

Alarm setpoints are entered digit by digit. Place the highlight over the setpoint to be adjusted and press **P**; the flashing digit to be adjusted may then be selected by again pressing **P**. When all the digits have been adjusted, operating the **E** button enters the value and moves the menu up one level.

The function of all alarms may be reviewed from the alarm summary menu - see 6.3.5.1.

6.3.6 Display

6.3.6.1 Settings

The backlight brilliance and display contrast are adjustable from this sub-menu.

6.3.6.2 Quick Access

This sub-menu enables the Quick Access Menu which is described in sections 2.1 & 6.4. When enabled, an operator can adjust the display contrast and backlight brilliance without having access to any other conditioning menus.

6.3.6.3 Access Code

Defines a four digit alphanumeric code that must be entered to gain access to the Quick Access Menu. Alpha characters are case sensitive. Default code 0000 allows direct access without a code.

6.3.6.4 Status Text

The two single variable screens 1 and 4 will show the status of the FOUNDATION™ fieldbus variable as 'Good' or 'Bad' if the Status Text function is activated.

6.3.6.5 Last Input

This function allows the maximum number of FOUNDATION™ fieldbus variables to be defined so that unused inputs are skipped when the display is scrolled in the operating mode.

6.3.7 Keys

The function of the front panel push buttons may be transferred to the six optional external push buttons, with or without disabling the BA488CF-F front panel push buttons. The table below shows the function of the BA488CF-F front panel and the external push buttons for each of the four options that may be selected in the Keys sub-menu.

Selected option from Keys sub-menu	Push buttons	Function of push buttons		
		Screen scrolling	P+E access to configuration menu	P+Up access to quick access menu
Internal	BA488CF-F	Yes	Yes	Yes
	External	No	No	No
External	BA488CF-F	No	Yes	No
	External	Yes	Yes	Yes
Both	BA488CF-F	Yes	Yes	Yes
	External	Yes	Yes	Yes
Internal + Port	BA488CF-F	Yes	Yes	Yes
	External	No	No	No

For applications where the instrument is only displaying 1, 2, 3, 4 or 8 variables on a single screen, it is recommended that external buttons are selected but not fitted. This will disable the instrument front panel buttons, but still provide access to the configuration menu, which may be protected by a security code.

6.3.8 Code

Defines the four digit alphanumeric code that must be entered to gain access to the instrument configuration menus. Alpha characters are case sensitive. Default code 0000 allows direct access without a code.

6.3.9 Unit Info

Displays the instrument model number and the firmware version.

6.3.10 Defaults

This function enables the display and interface board factory defaults to be restored. The function blocks (Revision 1 or 2) should be selected to suit the system host.

6.3.10.1 Display Defaults

This function restores the display defaults defined in section 6.1.

CAUTION

Existing settings can not be recovered after this function has been used.

6.3.10.2 Interface Board Defaults

This function restores the Fieldbus Interface Board factory defaults.

CAUTION

Do not use this function when the BA488CF-F is connected to an operational fieldbus, as communication will be terminated.

6.3.10.3 Revisions 1 and 2

Unless specified at the time of ordering, BA488CF-F FOUNDATION™ fieldbus displays will be supplied as Revision 2 instruments. i.e. two input selector function blocks (2 x IS), but it can easily be converted to a Revision 1 instrument using the Default menu. i.e one multiple analogue output function block (1 x MAO).

The BA488CF-F FOUNDATION™ fieldbus display revision should be chosen so that the fieldbus function blocks selected are supported by the system host.

To change the BA488CF-F FOUNDATION™ fieldbus display revision, highlight the required revision in the 'Restore Defaults' menu and follow the screen prompts until 'Defaults Loaded Now power cycle the unit' is displayed. To complete the installation remove the BA488CF-F power supply for a few seconds, when power is restored the instrument will restart with the selected revision.

6.4 Quick Access Menu

The Quick Access Menu allows an operator to adjust the backlight brilliance and the display contrast without having access to the other configuration parameters.

The quick access menu is accessed by operating the **P** and **▲** push buttons simultaneously. If the Quick Access Menu is not protected by an access code the contrast and brilliance controls will be displayed immediately. If an access code other than the default code 0000 has already been entered, the BA488CF-F will request that the access code be entered.

The backlight brilliance is adjusted using the **▼** and **▲** push buttons. Operating the **P** push button will transfer control to the display contrast adjustment. When both are set as required, operating the **E** button will store both settings and return the instrument to the operating mode.

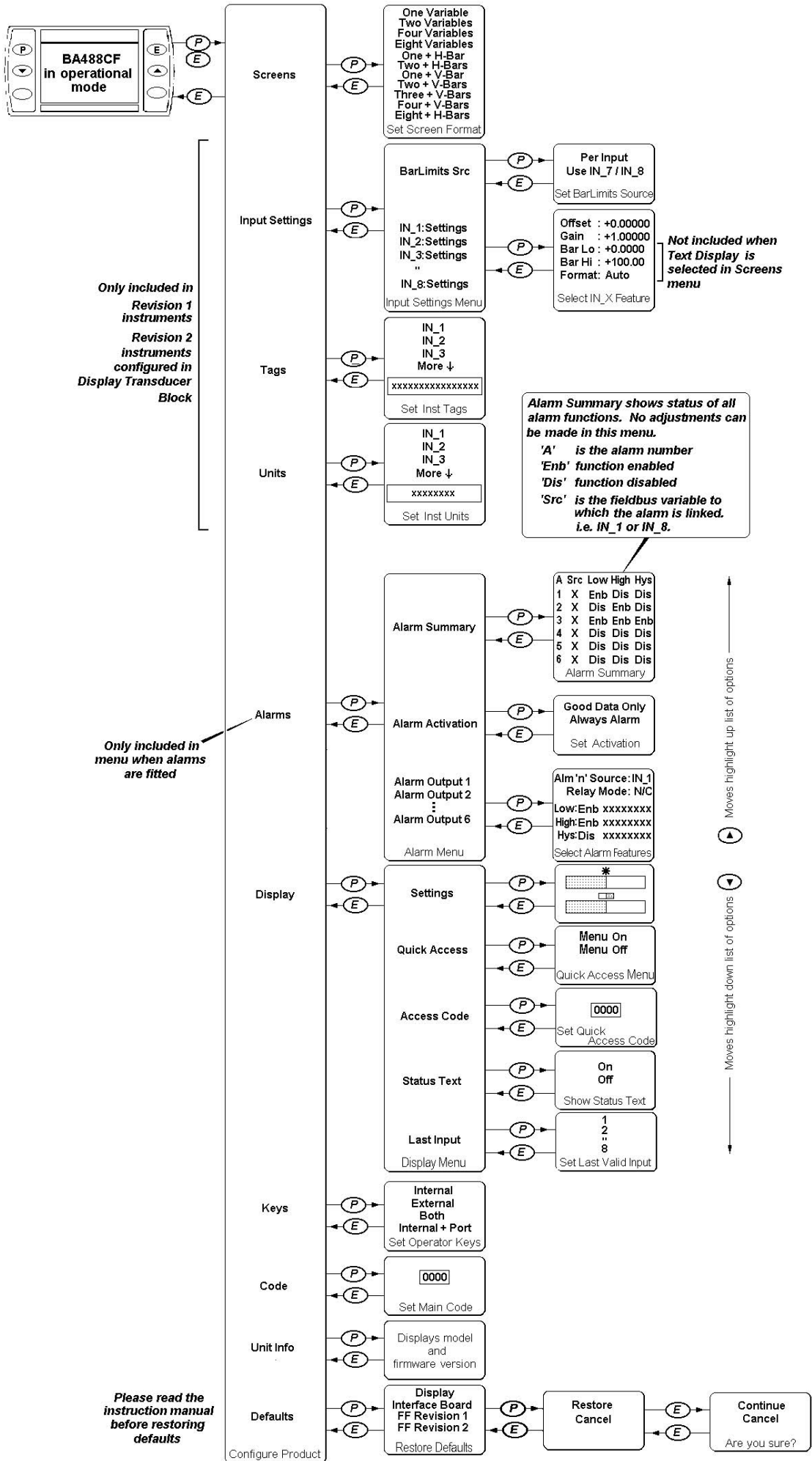

Fig 7 Structure of Configuration Menu

7. PROGRAMMING

The 'Text Display' option which enabled custom formats to be created is depreciated i.e. still available but no longer actively supported.

8. MAINTENANCE

8.1 Fault finding during commissioning

If a BA488CF-F FOUNDATION™ fieldbus display fails to function during commissioning the following procedure should be followed:

Symptom	Cause	Check:
No Display	Fieldbus not powered	9 to 17.5V between terminals 1 & 2.
No variables	Fieldbus not configured BA488CF-F does not have correct protocol	Instrument configuration at host That the BA488CF-F protocol is the same as the fieldbus. i.e. Fieldbus Foundation or Profibus PA.
Wrong variable displayed	Wrong screen selected	Other screens by operating <i>Up</i> or <i>Down</i> button
Display shows "?????"	Display Overrange	Number Format see section 6.3.2
No backlight	Brilliance turned down	Setting in display menu
Low or excessive contrast	Incorrect contrast setting	Setting in display menu
Displayed variable is inverted i.e. light digits on dark background	Variable has 'bad' status	Configuration and instrument supplying variable
Displayed variable is flashing	Associated alarm has been activated	Setpoints
Bargraph on standard display format is shown dotted	Displayed fieldbus variable is outside bargraph limits or data is 'bad'	Bargraph limits see section 6.3.2

8.2 Fault finding after commissioning

ENSURE PLANT SAFETY BEFORE STARTING MAINTENANCE

Live maintenance is permitted on intrinsically safe equipment installed in a hazardous area, but only certified test equipment should be used unless a gas clearance certificate is available.

If a BA488CF-F fails after it has been functioning correctly, the table shown in section 8.1 may help to identify the cause of the failure.

If this procedure does not reveal the cause of the fault, it is recommended that the instrument is replaced.

8.3 Servicing

We recommend that faulty BA488CF-F FOUNDATION™ fieldbus displays are returned to BEKA associates or to our local agent for repair.

8.4 Routine maintenance

The mechanical and electrical condition of the instrument should be regularly checked. Initially annual inspections are recommended, although the inspection frequency should be adjusted to suit the environmental conditions.

8.5 Guarantee

Instruments which fail within the guarantee period should be returned to BEKA associates or our local agent. It is helpful if a brief description of the fault symptoms is provided.

8.6 Customer comments

BEKA associates is always pleased to receive comments from customers about our products and services. All communications are acknowledged and whenever possible, suggestions are implemented.

9. ACCESSORIES

9.1 Tag number

The BA488CF-F can be supplied with a thermally printed tag number on the rear panel. This tag number is not visible from the front of the instrument after installation.

9.2 FOUNDATION™ fieldbus Interface Guide

The BEKA FOUNDATION™ fieldbus Interface Guide which may be downloaded from the BEKA web site at www.beka.co.uk contains conditioning information for all BEKA FOUNDATION™ fieldbus products.

10. INDEX

Subject	Section	Subject	Section
Alarms	6.3.5	Notified Body	1; 3.1
Activation	6.3.5.2	Number Format	6.3.2
Output	3.5; 6.3.5.3; 4.4	Programming	7.
Summary	6.3.5.1	Guide	7; 9.2
ATEX Directive	3.1	Profibus PA	1
Backlight	6.3.6.1	Quick access menu	6.3.6.2; 6.4
Bargraph Limits	6.3.2	Revisions 1 & 2	1; 6.3.10.3
Certificates		Servicing	8.3
EC-Type Examination	3.1	Screens (display format)	6.3.1
Label	3.6	Status text	6.3.6.4
Configuration menu	Fig 7	Tags	6.3.3
Controls	2.1	Tag number	9.1
Code	6.3.8	T rating	3.2; Appendix 1; 2
Decimal points	6.3.2	Terminal numbers	Fig 6
Default settings	6.1; 6.3.10	Units (of measurement)	6.3.4
Display	6.3.6	Unit Info (firmware version)	6.3.9
Access code	6.3.6.3	Zones	3.2; Appendix 1; 2
Settings	6.3.6.1		
Quick access	6.3.6.2; 6.4		
EMC	5.3		
External switches	3.4; 4.3; 6.3.7		
Fault finding			
During commissioning	8.1		
After commissioning	8.2		
Fieldbus			
Connection	3.3		
Interface Guide	9.3		
Revisions 1 & 2	6.3.10.3		
FISCO	3.3; 4.1		
FOUNDATION™ fieldbus	1; 2		
FM Approval	Appendix 1		
Gas groups	3.2; Appendix 1; 2		
Guarantee	8.5		
IECEX Certification	Appendix 2		
Input Scaling	6.3.2		
Installation	5.		
Intrinsic safety	3; Appendix 1; 2		
Keys	6.3.7		
Last input	6.3.6.4		
Location	5.1		
	Appendix 1; 2		
Maintenance	8.		
Routine	8.4		

APPENDIX 1

FM approval for use in USA

A1.0 Factory Mutual Approval

For installations in the USA, the BA488CF-F FOUNDATION™ fieldbus display and optional alarms have been approved intrinsically safe and nonincendive by FM Approvals, project identification 3022546. Copies of the Certificate of Compliance are available from BEKA associates.

A1.1 Intrinsic safety approval

The BA488CF-F is approved to the FM Class 3610 intrinsic safety standard for use in indoor hazardous (classified) locations. Installations must comply with BEKA associates Control Drawing CI480-17, which is attached to this Appendix, ANSI/ISA RP12.06.01 'Installation of Intrinsically Safe Systems for Hazardous (Classified) Locations' and with the National Electrical Code ANSI/NFPA70.

The BA488CF-F has a T4 rating at ambient temperatures up to +60°C and may be used with the following gases and dusts:

Intrinsic Safety	
Division 1 or 2	
Class I	Group A & B Group C Group D
Zone 0, 1 or 2	
Class 1	Group IIC Group IIB Group IIA

The FM entity parameters are identical to the ATEX parameters and, like the ATEX certification, confirm that terminals 1 & 2 of the BA488CF-F comply with the requirements for a FISCO Field Device specified in IEC60079-27. The intrinsically safe circuits shown in Figs 2 and 3 of this manual may therefore be used for installations in the USA, providing the fieldbus power supply, terminators, Zener barriers and galvanic isolators are FM Approved and comply with BEKA associates Control Drawing CI480-17. The FM Approval also allows the BA488CF-F to be connected to non-FISCO systems using the entity concept – see section 4.2 of this manual.

A1.2 Nonincendive approval



The BA488CF-F FOUNDATION™ fieldbus display is Class 3611 nonincendive approved by Factory Mutual allowing it to be installed in Division 2 indoor hazardous (classified) locations without the need for Zener barriers or galvanic isolators. Installations must comply with the BEKA associates Control Drawing CI480-18, which is attached to this Appendix, and with the National Electrical Code ANSI/NFPA70.

The FM Nonincendive Approval also allows the instrument to be connected to any FNICO compliant fieldbus segment powered by FM Approved Associated Nonincendive Field Wiring Apparatus.

The BA488CF-F has a T4 rating at ambient temperatures up to +60°C and may be used with the following gases and dusts:

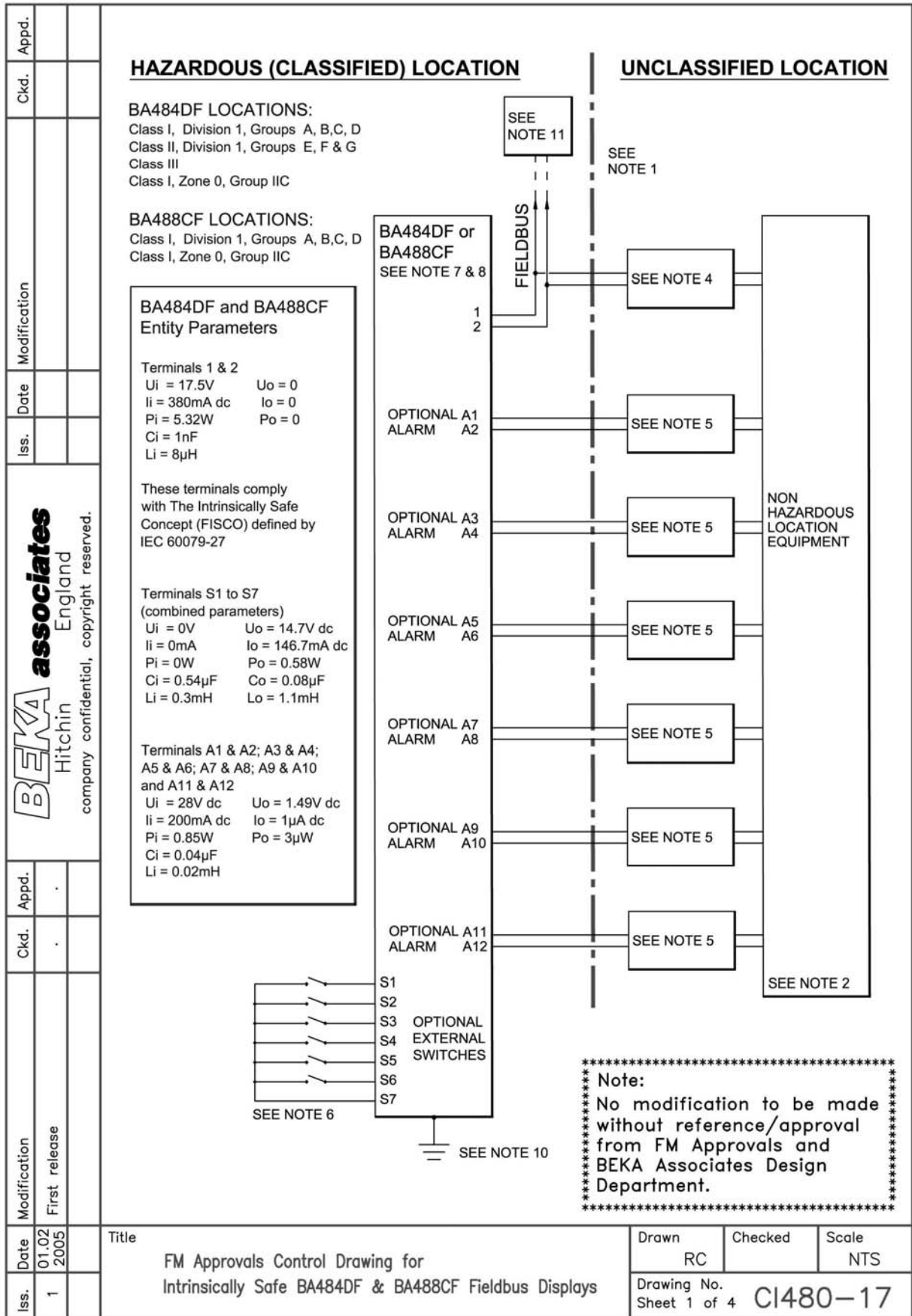
Nonincendive	
Division 2	
Class I	Group A & B Group C Group D
Zone 2	
Class I	Group IIC Group IIB Group IIA



Iss.		Date		Modification		Iss.		Date		Modification		Ckd.		Appd.																																															
																																																													
<p>8. When installed in a hazardous (classified) location the BA484DF Fieldbus Display shall be fitted with cable glands / conduit hubs selected from the following table Metallic glands and hubs must be grounded – see note 9.</p> <table border="1" style="width: 100%; border-collapse: collapse;"> <thead> <tr> <th style="width: 20%;">Class</th> <th>Permitted gland or conduit hub</th> </tr> </thead> <tbody> <tr> <td>Class I</td> <td>Any metallic or plastic cable gland or conduit hub that provides the required environmental protection.</td> </tr> <tr> <td>Class II and III</td> <td> Crouse – Hinds Myler hubs SSTG-1 STG-1 STAG-1 MHUB-1 O-Z / Gedrey Hubs CHMG-50DT REMKE hub WH-1-G Killark Glands CMCXAA050 MCR050 MCX050 </td> </tr> </tbody> </table> <p>9. In addition to the supplied bonding plate, when 2 or 3 metallic glands or conduit hubs are fitted to a BA484DF Fieldbus Display, all metallic glands or conduit hubs must be connected together and grounded.</p> <p>10. CAUTION: The BA484DF and BA488CF Fieldbus Display enclosures are manufactured from conductive plastic per Article 250 of the National Electrical Code the enclosures shall be grounded using the 'E' terminal on the terminal block.</p> <p>11. The terminator on the Fieldbus must be FM Approved.</p> <p>12. The BA484DF should be mounted where it is shielded from direct sunlight.</p> <p style="text-align: right;">Cont.</p>																Class	Permitted gland or conduit hub	Class I	Any metallic or plastic cable gland or conduit hub that provides the required environmental protection.	Class II and III	Crouse – Hinds Myler hubs SSTG-1 STG-1 STAG-1 MHUB-1 O-Z / Gedrey Hubs CHMG-50DT REMKE hub WH-1-G Killark Glands CMCXAA050 MCR050 MCX050																																								
Class	Permitted gland or conduit hub																																																												
Class I	Any metallic or plastic cable gland or conduit hub that provides the required environmental protection.																																																												
Class II and III	Crouse – Hinds Myler hubs SSTG-1 STG-1 STAG-1 MHUB-1 O-Z / Gedrey Hubs CHMG-50DT REMKE hub WH-1-G Killark Glands CMCXAA050 MCR050 MCX050																																																												
																																																													
<table border="1" style="width: 100%; border-collapse: collapse;"> <tr> <td style="width: 5%; text-align: center;">Iss.</td> <td style="width: 5%; text-align: center;">1</td> <td style="width: 10%; text-align: center;">Date</td> <td style="width: 10%;">01.02 2005</td> <td style="width: 10%; text-align: center;">Modification</td> <td style="width: 10%;">First release</td> <td style="width: 10%; text-align: center;">Ckd.</td> <td style="width: 10%;"></td> <td style="width: 10%; text-align: center;">Appd.</td> <td style="width: 10%;"></td> <td style="width: 10%;"></td> <td style="width: 10%;"></td> <td style="width: 10%;"></td> <td style="width: 10%;"></td> <td style="width: 10%;"></td> <td style="width: 10%;"></td> </tr> <tr> <td colspan="11" style="text-align: center;"> Title FM Approvals Control Drawing for Intrinsically Safe BA484DF & BA488CF Fieldbus Displays </td> <td style="width: 10%; text-align: center;"> Drawn RC </td> <td style="width: 10%; text-align: center;"> Checked NTS </td> <td style="width: 10%; text-align: center;"> Scale NTS </td> </tr> <tr> <td colspan="11"></td> <td colspan="5" style="text-align: center;"> Drawing No. Sheet 3 of 4 CI480-17 </td> </tr> </table>																Iss.	1	Date	01.02 2005	Modification	First release	Ckd.		Appd.								Title FM Approvals Control Drawing for Intrinsically Safe BA484DF & BA488CF Fieldbus Displays											Drawn RC	Checked NTS	Scale NTS												Drawing No. Sheet 3 of 4 CI480-17				
Iss.	1	Date	01.02 2005	Modification	First release	Ckd.		Appd.																																																					
Title FM Approvals Control Drawing for Intrinsically Safe BA484DF & BA488CF Fieldbus Displays											Drawn RC	Checked NTS	Scale NTS																																																
											Drawing No. Sheet 3 of 4 CI480-17																																																		

Iss.		Date		Modification		Ckd.		Appd.	
1		01.02 2005		First release					
<p style="text-align: center;">BEKA associates Hitchin England company confidential, copyright reserved.</p>									
<p>FISCO Rules</p> <p>The FISCO Concept allows the interconnection of intrinsically safe apparatus to associated apparatus not specifically examined in such combination. The criterion for such interconnection is that the voltage (V_{max}), the current (I_{max}) and the power (P_{max}) which intrinsically safe apparatus can receive and remain intrinsically safe, considering faults, must be equal or greater than the voltage (U_0, V_{oc} or V_t), the current (I_0, I_{sc} or I_t) and the power (P_0) which can be provided by the associated apparatus (supply unit). In addition the maximum unprotected residual capacitance (C_i) and inductance (L_i) of each apparatus (other than terminators) connected to the Fieldbus must be less than or equal to 5nF and 10uH respectively.</p> <p>In each I.S. Fieldbus segment only one active source, normally the associated apparatus, is allowed to provide the necessary power for the Fieldbus system. The allowed voltage (U_0, V_{oc} or V_t) of the associated apparatus used to supply the bus cable must be limited to the range 14Vdc to 24Vdc. All other equipment connected to the bus cable has to be passive, meaning that the apparatus is not allowed to provide energy to the system, except a leakage current of 50µA for each connected device. Separately powered equipment needs galvanic isolation to ensure the intrinsically safety Fieldbus circuit remains passive.</p> <p>The cable used to interconnect the devices needs to comply with the following parameters: Loop resistance R': 15....150Ω/km Inductance per unit length L': 0.4....1mH/km</p> <p>Capacitance per unit length C': 80....200nF/km $C' = C'$ line/line+0.5 C' line/screen, if both lines are floating or $C' = C'$ line/line + C'line/screen, if the screen is connected to one line.</p> <p>Length of spur cable: max. 30m Length of trunk cable: max. 1km Length of splice: max = 1m</p> <p>Terminators At the end of each trunk cable an FM Approved line terminator with the following parameters is suitable: $R = 90....100\Omega$ $C = 02.2\mu F$</p> <p>System evaluation The number of passive devices like transmitters, actuators, connected to a single bus segment is not limited due to I.S. reasons. Furthermore, if the above rules are respected, the inductance and the capacitance of the cable need not be considered and will not impair the intrinsic safety of the installation.</p> <p>Notes. 1. The intrinsic safety FISCO concept allows the interconnection of FM Approved Intrinsically Safe devices with FISCO parameters not specifically examined in combination as a system when: U_0 or V_{oc} or $V_t \leq V_{max}$, I_0, I_{sc} or $I_t \leq I_{max}$, $P_0 \leq P_i$."</p>									
Date		Title		Drawn		Checked		Scale	
01.02 2005		FM Approvals Control Drawing for Intrinsically Safe BA484DF & BA488CF Fieldbus Displays		RC				NTS	
Iss.		Date		Drawing No.		Sheet 4 of 4			
1				CI480-17					

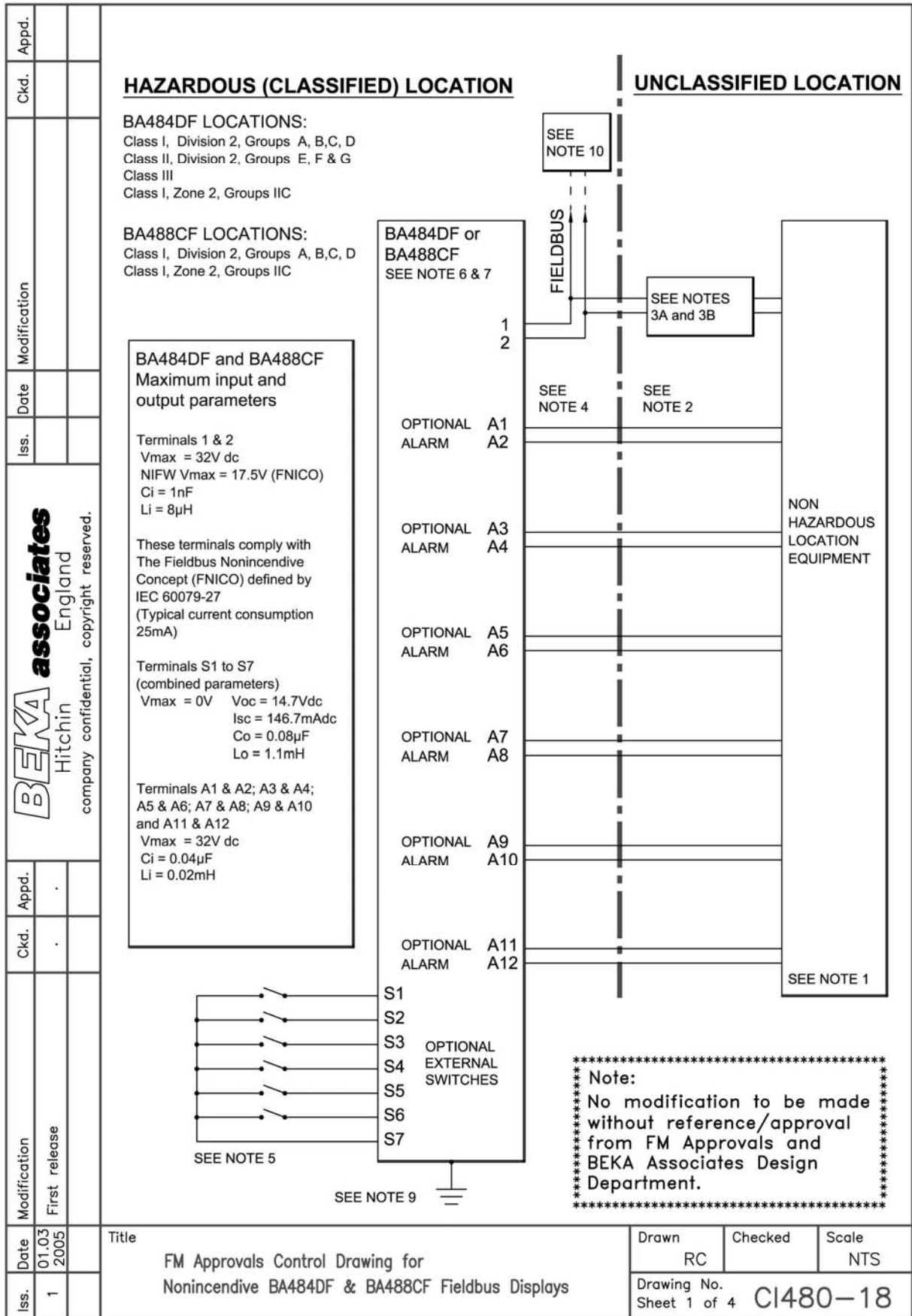

 Note:
 No modification to be made
 without reference/approval
 from FM Approvals and
 BEKA Associates Design
 Department.

Iss.		Date		Modification		Appd.		<p>Notes:</p> <ol style="list-style-type: none"> The unclassified location equipment connected to the associated nonincendive field wiring apparatus must not use or generate more than 250V rms or 250V dc. Nonincendive field wiring installations shall be in accordance with the National Electrical Code ANSI/NFPA 70. The Nonincendive Field Wiring concept allows interconnection of Nonincendive Field Wiring Apparatus with Associated Nonincendive Field Wiring Apparatus using any of the wiring methods permitted for unclassified locations. Linear power supply A linear fieldbus power supply shall be: FM Approved Associated Nonincendive Field Wiring Apparatus installed in the unclassified location with parameters complying with the following requirements: OR FM Approved Nonincendive Field Wiring Apparatus installed in the classified location with parameters complying with the following requirements: <table border="0"> <tr> <td>Voc</td> <td>equal to or less than</td> <td>Vmax</td> </tr> <tr> <td>La</td> <td>equal to or greater than</td> <td>Lcable + Li</td> </tr> <tr> <td>Ca</td> <td>equal to or greater than</td> <td>Ccable + Ci</td> </tr> </table> FNICO non-linear power supply A FNICO non-linear fieldbus power supply shall be: FM Approved Associated Nonincendive Field Wiring Apparatus installed in the unclassified location complying with the following table: OR FM Approved Nonincendive Field Wiring Apparatus installed in the classified location complying with the following table: <table border="0"> <tr> <td>Voc</td> <td>Maximum current for Groups AB [IIC]</td> <td>Maximum current for Groups CD [IIB, IIA]</td> </tr> <tr> <td>V</td> <td>mA</td> <td>mA</td> </tr> <tr> <td>14</td> <td>274</td> <td>570</td> </tr> <tr> <td>15</td> <td>199</td> <td>531</td> </tr> <tr> <td>16</td> <td>154</td> <td>432</td> </tr> <tr> <td>17</td> <td>121</td> <td>360</td> </tr> <tr> <td>17.5</td> <td>112</td> <td>319</td> </tr> </table> Apparatus connected to the optional alarm contacts shall be FM Approved as Associated Nonincendive Field Wiring Apparatus and shall comply with the following requirements: <table border="0"> <tr> <td>Voc</td> <td>equal to or less than</td> <td>Vmax</td> </tr> <tr> <td>La</td> <td>equal to or greater than</td> <td>Lcable + Li</td> </tr> <tr> <td>Ca</td> <td>equal to or greater than</td> <td>Ccable + Ci</td> </tr> </table> Terminals S1 to S7 shall be connected to simple apparatus or volt free contacts of FM Approved Nonincendive Field Wiring Apparatus or FM Approved Associated Nonincendive Field Wiring Apparatus installed using Division 2 wiring methods. To maintain IP65 protection between the BA488CF and the mounting panel: Four panel mounting clips should be used Minimum panel thickness should be 2mm (0.08inches) Steel 3mm (0.12inches) Aluminium Outside panel finish should be smooth, free from particle inclusions, runs or build-up around cut-out. Panel cut-out should be 66.2 x 136.0mm -0.0 +0.5 (2.60 x 5.35 inches -0.00 +0.02) Edges of panel cut-out should be deburred and clean Each panel mounting clip should be tightened to between: 20 and 22cNm (1.77 to 1.95 inLb) <p style="text-align: right;">Cont.</p>	Voc	equal to or less than	Vmax	La	equal to or greater than	Lcable + Li	Ca	equal to or greater than	Ccable + Ci	Voc	Maximum current for Groups AB [IIC]	Maximum current for Groups CD [IIB, IIA]	V	mA	mA	14	274	570	15	199	531	16	154	432	17	121	360	17.5	112	319	Voc	equal to or less than	Vmax	La	equal to or greater than	Lcable + Li	Ca	equal to or greater than	Ccable + Ci
Voc	equal to or less than	Vmax																																													
La	equal to or greater than	Lcable + Li																																													
Ca	equal to or greater than	Ccable + Ci																																													
Voc	Maximum current for Groups AB [IIC]	Maximum current for Groups CD [IIB, IIA]																																													
V	mA	mA																																													
14	274	570																																													
15	199	531																																													
16	154	432																																													
17	121	360																																													
17.5	112	319																																													
Voc	equal to or less than	Vmax																																													
La	equal to or greater than	Lcable + Li																																													
Ca	equal to or greater than	Ccable + Ci																																													
Iss.		Date		Modification		Appd.																																									
Iss.		Date		Modification		Appd.																																									
Iss.		Date		Modification		Appd.																																									
Iss.		Date		Modification		Appd.																																									
Iss.		Date		Modification		Appd.																																									
Iss.		Date		Modification		Appd.																																									
Iss.		Date		Modification		Appd.																																									
Iss.	1	01.03 2005		First release																																											
Title		Drawn		Checked		Scale																																									
FM Approvals Control Drawing for Nonincendive BA484DF & BA488CF Fieldbus Displays		RC				NTS																																									
		Drawing No.		Sheet 2 of 4																																											
				CI480-18																																											

BEKA associates
Hitchin
England
company confidential, copyright reserved.

Iss.		Date		Iss.		Date		Modification		Ckd.		Appd.																			
																															
<p>7. When installed in a hazardous (classified) location the BA484DF Fieldbus Display shall be fitted with cable glands / conduit hubs selected from the following table.</p> <p style="margin-left: 40px;">Metallic glands and hubs must be grounded – see note 8.</p> <table border="1" style="margin-left: auto; margin-right: auto; border-collapse: collapse;"> <thead> <tr> <th style="width: 15%;">Class</th> <th style="width: 85%;">Permitted gland or conduit hub</th> </tr> </thead> <tbody> <tr> <td style="text-align: center;">Class I</td> <td>Any metallic or plastic cable gland or conduit hub that provides the required environmental protection.</td> </tr> <tr> <td style="text-align: center;">Class II and III</td> <td> <p>Crouse – Hinds Myler hubs SSTG-1 STG-1 STAG-1 MHUB-1</p> <p>O-Z / Gedrey hub CHMG-50DT</p> <p>REMKE hub WH-1-G</p> <p>Killark Glands CMCXAA050 MCR050 MCX050</p> </td> </tr> </tbody> </table> <p>8. In addition to the supplied bonding plate, when 2 or 3 metallic glands or conduit hubs are fitted to a BA484DF Fieldbus Display, all metallic glands or conduit hubs must be connected together and grounded.</p> <p>9. CAUTION: The BA484DF and BA488CF Fieldbus Display enclosures are manufactured from conductive plastic per Article 250 of the National Electrical Code the enclosures shall be grounded using the 'E' terminal on the terminal block.</p> <p>10. The terminator on the Fieldbus must be FM Approved.</p> <p>11. The BA484DF should be mounted where it is shielded from direct sunlight.</p> <p style="text-align: right;">Cont.</p>														Class	Permitted gland or conduit hub	Class I	Any metallic or plastic cable gland or conduit hub that provides the required environmental protection.	Class II and III	<p>Crouse – Hinds Myler hubs SSTG-1 STG-1 STAG-1 MHUB-1</p> <p>O-Z / Gedrey hub CHMG-50DT</p> <p>REMKE hub WH-1-G</p> <p>Killark Glands CMCXAA050 MCR050 MCX050</p>												
Class	Permitted gland or conduit hub																														
Class I	Any metallic or plastic cable gland or conduit hub that provides the required environmental protection.																														
Class II and III	<p>Crouse – Hinds Myler hubs SSTG-1 STG-1 STAG-1 MHUB-1</p> <p>O-Z / Gedrey hub CHMG-50DT</p> <p>REMKE hub WH-1-G</p> <p>Killark Glands CMCXAA050 MCR050 MCX050</p>																														
<table border="1" style="width: 100%; border-collapse: collapse;"> <tr> <td style="width: 10%; text-align: center;">Date</td> <td style="width: 10%;">01.03 2005</td> <td style="width: 40%; text-align: center;">Title</td> <td style="width: 10%; text-align: center;">Drawn</td> <td style="width: 10%; text-align: center;">Checked</td> <td style="width: 10%; text-align: center;">Scale</td> </tr> <tr> <td style="text-align: center;">Iss.</td> <td style="text-align: center;">1</td> <td style="text-align: center;">FM Approvals Control Drawing for Nonincendive BA484DF & BA488CF Fieldbus Displays</td> <td style="text-align: center;">RC</td> <td></td> <td style="text-align: center;">NTS</td> </tr> <tr> <td colspan="3"></td> <td colspan="3" style="text-align: center;">Drawing No. Sheet 3 of 4 CI480-18</td> </tr> </table>														Date	01.03 2005	Title	Drawn	Checked	Scale	Iss.	1	FM Approvals Control Drawing for Nonincendive BA484DF & BA488CF Fieldbus Displays	RC		NTS				Drawing No. Sheet 3 of 4 CI480-18		
Date	01.03 2005	Title	Drawn	Checked	Scale																										
Iss.	1	FM Approvals Control Drawing for Nonincendive BA484DF & BA488CF Fieldbus Displays	RC		NTS																										
			Drawing No. Sheet 3 of 4 CI480-18																												

Iss.	Date	Modification	Ckd.	Appd.	<p>BEKA associates Hitchin England company confidential, copyright reserved.</p>	<p>FNICO Rules</p> <p>The FNICO Concept allows the interconnection of intrinsically safe apparatus to associated apparatus not specifically examined in such combination. The criterion for such interconnection is that the voltage (Vmax), the current (Imax) and the power (Pmax) which intrinsically safe apparatus can receive and remain intrinsically safe, considering faults, must be equal or greater than the voltage (Uo, Voc or Vt), the current (Io, Isc or It) and the power (Po) which can be provided by the associated apparatus (supply unit). In addition the maximum unprotected residual capacitance (Ci) and inductance (Li) of each apparatus (other than terminators) connected to the Fieldbus must be less than or equal to 5nF and 20uH respectively.</p> <p>In each I.S. Fieldbus segment only one active source, normally the associated apparatus, is allowed to provide the necessary power for the Fieldbus system. The allowed voltage (Uo, Voc or Vt) of the associated apparatus used to supply the bus cable must be limited to the range 14Vdc to 17.5Vdc. All other equipment connected to the bus cable has to be passive, meaning that the apparatus is not allowed to provide energy to the system, except a leakage current of 50µA for each connected device. Separately powered equipment needs galvanic isolation to ensure the intrinsically safety Fieldbus circuit remains passive.</p> <p>The cable used to interconnect the devices needs to comply with the following parameters: Loop resistance R': 15....150Ω/km Inductance per unit length L': 0.4....1mH/km</p> <p>Capacitance per unit length C': 80....200nF/km C' = C' line/line+0.5 C' line/screen, if both lines are floating or C' = C' line/line + C'line/screen, if the screen is connected to one line. Length of spur cable: max. 30m Length of trunk cable: max. 1km Length of splice: max = 1m Terminators At the end of each trunk cable an FM Approved line terminator with the following parameters is suitable: R= 90...100Ω C = 0....2.2µF</p> <p>System evaluation The number of passive devices like transmitters, actuators, connected to a single bus segment is not limited due to nonincendive reasons. Furthermore, if the above rules are respected, the inductance and the capacitance of the cable need not be considered and will not impair the intrinsic safety of the installation.</p> <p>Notes. 1. The intrinsic safety FNICO concept allows the interconnection of FM Approved nonincendive devices with FNICO parameters not specifically examined in combination as a system when: Uo or Voc or Vt ≤ Vmax"</p>
Iss.	Date	Modification	Ckd.	Appd.		
Iss.	Date	Modification	Ckd.	Appd.		
Iss.	Date	Modification	Ckd.	Appd.		
Iss.	Date	Modification	Ckd.	Appd.		
Iss.	Date	Modification	Ckd.	Appd.	<p>Title</p> <p>FM Approvals Control Drawing for Nonincendive BA484DF & BA488CF Fieldbus Displays</p>	<p>Drawn RC</p> <p>Checked</p> <p>Scale NTS</p>
Iss.	Date	Modification	Ckd.	Appd.	<p>Drawing No. Sheet 4 of 4</p> <p>CI480-18</p>	

APPENDIX 2

IECEX Certification

A2.0 The IECEX Certification Scheme

IECEX is a global certification scheme for explosion protected products which aims to harmonise international certification standards. For additional information about the IECEX certification scheme and to view the BEKA associate certificates, please visit www.iecex.com

A2.1 IECEX Certificate of Conformity

The BA488CF-F Fieldbus Display has been issued with an IECEX Certificate of Conformity number IECEX ITS 05.0007 which specifies the following certification code and marking:

For gas	Ex ia IIC T4
	Ta = -40°C to 60°C

The specified intrinsic safety parameters are identical to the ATEX parameters and confirm that terminals 1 & 2 comply with the requirements for a FISCO Field Device specified in IEC 60079-27.

The IECEX certificate may be downloaded from www.beka.co.uk, www.iecex.com or requested from the BEKA sales office.

A2.2 Installation

As the IECEX and ATEX certifications specify identical safety parameters and installation requirements for both are defined by IEC 60079-14, the ATEX installation requirements specified in sections 3.2 to 5.3 may also be used for IECEX installations. The local code of practice should also be consulted.